



**N
O
V
I
T
A'
C
E
R
S
A
I
E**

**20
24**



KEY 20X120 Rettificato



KEY120BG KEY BEIGE 20X120 RETT - F0171



LEGNI TEAK 7,5X60 - L60



KEY120GR KEY GREY 20X120 RETT - F0171



LEGNI FRASSINO 7,5X60 - L60

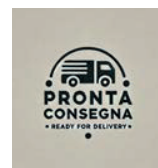

FORMATO	Spess. mm	Pz. x Scat.	M2 x scat. netto	Scat. x pall.	M2 x pall.	kg x scat.	kg x pall.
20x120 rett	9.5	6	1,44	36	51,84	23,90	880,40

BARBADOS 20x120 / 30x120 Rettificato



BARBADOS GREY 20X120 RETT / 30X120 RETT - F024



BARBADOS MIELE 20X120 RETT / 30X120 RETT - F024



BARBADOS ROVERE 20X120 RETT / 30X120 RETT - F024

FORMATO	Spess. mm	Pz. x Scat.	M2 x scat. netto	Scat. x pall.	M2 x pall.	kg x scat.	kg x pall.
20x120 rett	9.5	6	1,44	36	51,84	25,50	938

ROVERE 20X120 Rettificato



Gress porcellanato smaltato

Rettificato

Monocalibro

Variazione Media

Resistenza al gelo

Opaco

Prodotti in Tecnologia Digitale

Per locali sottoposti a sollecitazioni medio/pesanti



ROVERE NOCE M.R0002 - 20X120 - F0140



ROVERE BEIGE M.R0002 - 20X120 - F0140

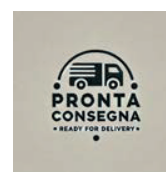

ROVERE BIANCO M.R0002 - 20X120 - F0140



ROVERE GRIGIO M.R0002 - 20X120 - F0140

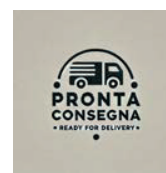

FORMATO	Spess. mm	Pz. x Scat.	M2 x scat. netto	Scat. x pall.	M2 x pall.	kg x scat.	kg x pall.
20x120 rett	9,5	6	1,44	36	51,84	30,20	1.070

NUANCE 20x120 / 30x120 Rettificato



Disponibile
Versione
R11

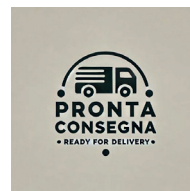

NUANCE Natural 20x120 rett / 30x120 rett - F024

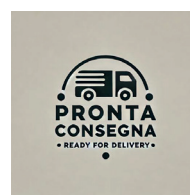

NUANCE Gold 20x120 rett / 30x120 rett - F024

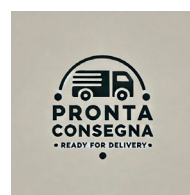

NUANCE White 20x120 rett / 30x120 rett - F024



NUANCE Grey 20x120 rett / 30x120 rett - F024

FORMATO	Spess. mm	Pz. x Scat.	M2 x scat. netto	Scat. x pall.	M2 x pall.	kg x scat.	kg x pall.
20x120 rett	9,5	6	1,44	36	51,84	25,50	938

STONE 60x120 / 60x60 / 30x60 Rettificato



ST Beige 60x120 rett - FO51



ST Grigio 60x120 rett - FO51



ST Antrax 60x120 rett - FO51



ST Beige 60x60 rett - FO49



ST Grigio 60x60 rett - FO49



ST Antrax 60x60 rett - FO49

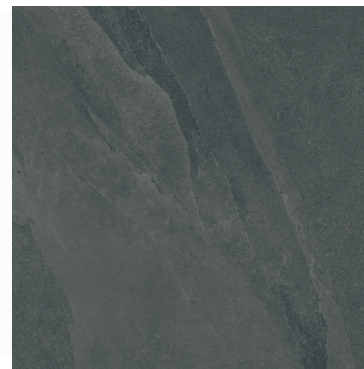

ST Beige 30x60 rett - FO56



ST Grigio 30x60 rett - FO56

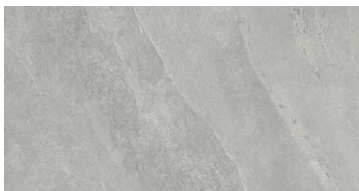

ST Antrax 30x60 rett - FO56

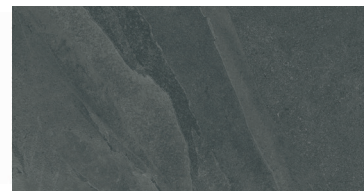

FORMATO	Spess. mm	Pz x Scat.	M2 x scat. netto	Scat. x pall.	M2 x pall.	kg x scat.	kg x pall.
60x120 rett	9,5	2	1,44	36	51,84	27,50	1010
30x60 rett.	9,2	7	1,26	60	75,60	23,50	1430
60x60 rett.	9,2	4	1,44	30	43,20	28,15	864,50

MR-MARMI 60x120 / 60x60 Rett. - 30,5x61 Naturale



Gress porcellanato smaltato



Rettificato



Monocalibro



Variazione Media



Resistenza al gelo



Opaco



Prodotti in Tecnologia Digitale



Per locali sottoposti a sollecitazioni medio/pesanti

MR Beige 60x120 rett - FO51



MR Grigio 60x120 rett - FO51

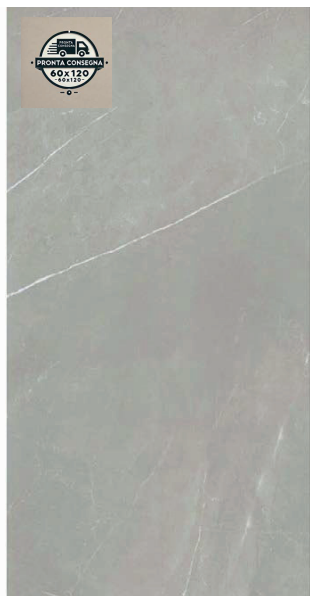

MR Perla 60x120 rett - FO51



MR Taupe 60x120 rett - FO51



MR Beige 60x60 rett - FO49



MR Grigio 60x60 rett - FO49

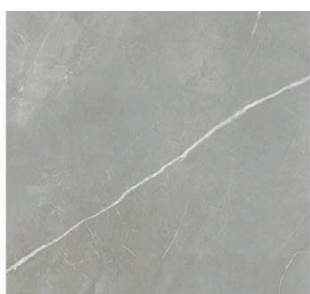

MR Perla 60x60 rett - FO49



MR Taupe 60x60 rett - FO49

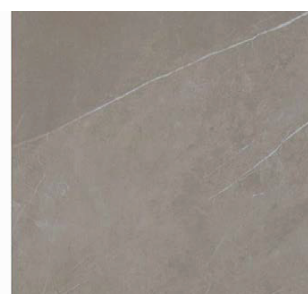

MR Beige 30,5x61 nat - FO55

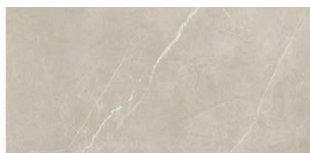

MR Grigio 30,5x61 nat - FO55

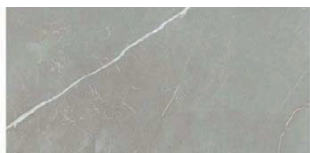

MR Perla 30,5x61 nat - FO55

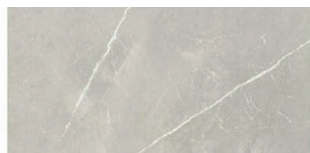

MR Taupe 30,5x61 nat - FO55

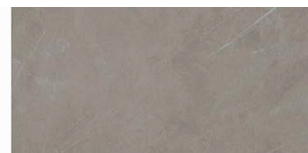

FORMATO	Spess. mm	Pz x Scat.	M2 x scat. netto	Scat. x pall.	M2 x pall.	kg x scat.	kg x pall.
60x120 rett	9,5	2	1,44	36	51,84	27,50	1010
30,5x61	8,2	8	1,49	60	89,4	23,60	1440
60x60 rett.	9,2	4	1,44	30	43,20	28,15	864,50

MARTE 60x120 / 60x60 Rettificato - 30,5x61 / 32,5x32,5 Naturale



Mrt Bianco 60x120 rett - FO51



Mrt Beige 60x120 rett - FO51

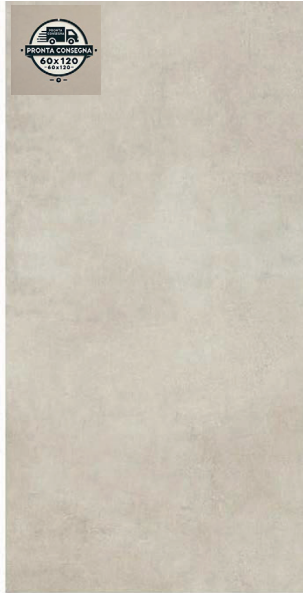

Mrt Grigio 60x120 rett - FO51



Mrt Taupe 60x120 rett - FO51



Mrt Bianco 60x60 rett - FO57



Mrt Beige 60x60 rett - FO57

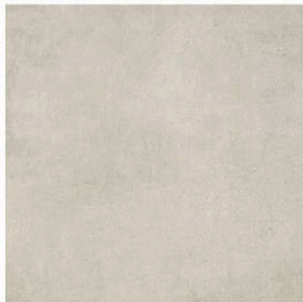

Mrt Grigio 60x60 rett - FO57



Mrt Taupe 60x60 rett - FO57



Mrt Bianco 30,5x61 - FO55



Mrt Beige 30,5x61 - FO55



Mrt Grigio 30,5x61 - FO55



Mrt Taupe 30,5x61 - FO55



Mrt Bianco 32,5x32,5 - FO61



Mrt Beige 32,5x32,5 - FO61



Mrt Grigio 32,5x32,5 - FO61



FORMATO	Spessore mm	Pz/Sc	Mq/Sc	Sc/PL	Mq/PL	Kg/Sc	Kg/PL
32,5x32,5	8,2 mm	14	1,48	69	102,12	22	1538
30,5x61	8,2 mm	8	1,49	60	89,40	23,50	1430,00
60x60 RT	8,2 mm	4	1,44	36	51,84	23,04	849,44
60x120 RT	9,5 mm	2	1,44	36	51,84	27,50	1010,00

FANCY 60x120 / 60x60 Rettificato



Gress porcellanato smaltato



Rettificato



Monocalibro



Variazione Media



Resistenza al gelo



Opaco



Prodotti in Tecnologia Digitale



Per locali sottoposti a sollecitazioni medio/pesanti

FY IVORY 60x120 rett - FO51



FY BEIGE 60x120 rett - FO51

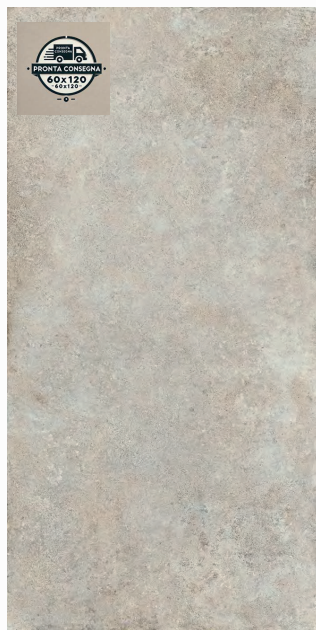

FY GREY 60x120 rett - FO51



FY DARK 60x120 rett - FO51



FY IVORY 60x60 rett - FO57



FY BEIGE 60x60 rett - FO57



FY GREY 60x60 rett - FO57



FY DARK 60x60 rett - FO57



FORMATO	Spess. mm	Pz x Scat.	M2 x scat. netto	Scat. x pall.	M2 x pall.	kg x scat.	kg x pall.
60x120 rett	9.5	2	1,44	36	51,84	27,50	1010
60x60 rett.	8.2	4	1,44	36	51,84	23,04	849,44

FLORA 60x120 Rettificato

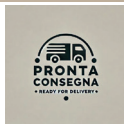

FLORA COLD 60X120 - FO58



FLORA WARM 60X120 - FO58

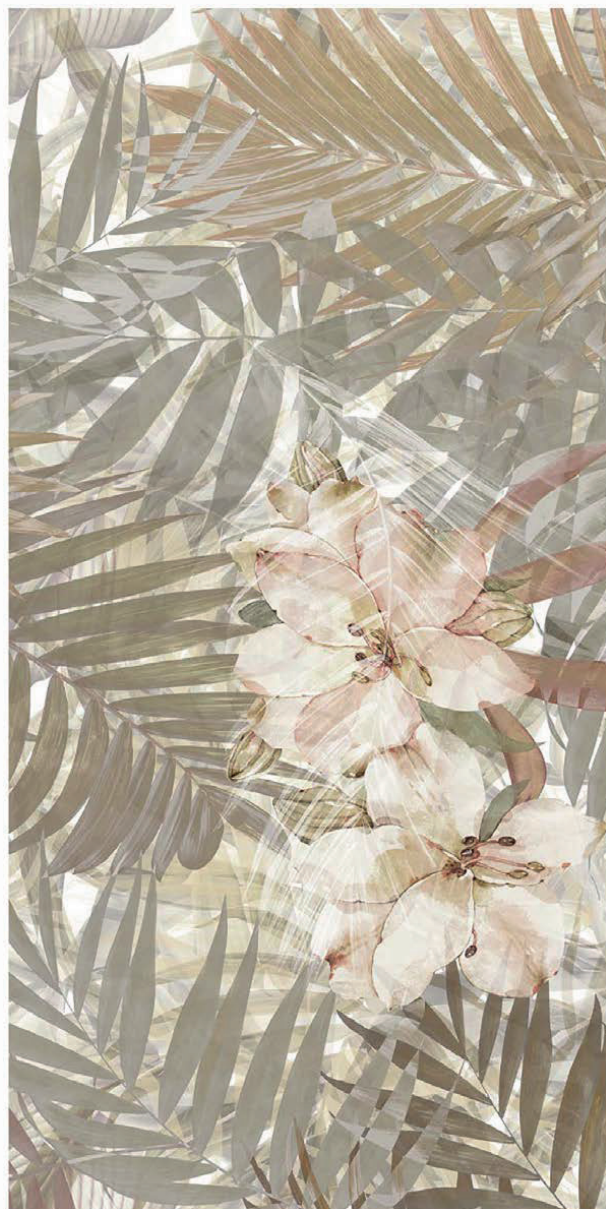

FORMATO	Spess. mm	Pz x Scat.	M2 x scat. netto	Scat. x pall.	M2 x pall.	kg x scat.	kg x pall.
60x120 rett	9,5	2	1,44	36	51,84	27,50	1010

IRON

MULTIFORMATO

60x60 / 30x60 / 60x120 / 80x80

COLORI

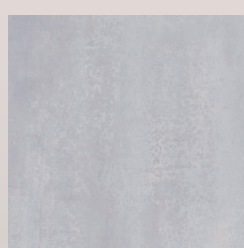
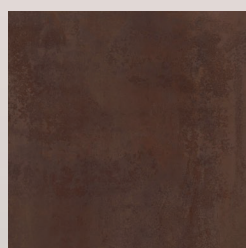
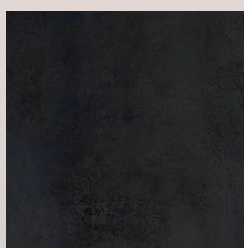

DECORI



IRON Multiformato + Grip 60x120 / 60x60 / 30x60 Rettificato

GP

Gress porcellanato smaltato

R

Rettificato

MC

Monocalibro

V3

Variazione Media



Resistenza al gelo



Opaco

DIGITAL TECHNOLOGY

Prodotti in Tecnologia Digitale



Per locali sottoposti a sollecitazioni medio/pesanti

Disponibile
Versione
R11



IRON PERLA

60X120 FO 117
60X60 FO 115
30X60 FO 115



IRON GRIGIO

60X120 FO 117
60X60 FO 115
30X60 FO 115



IRON BEIGE

60X120 FO 117
60X60 FO 115
30X60 FO 115

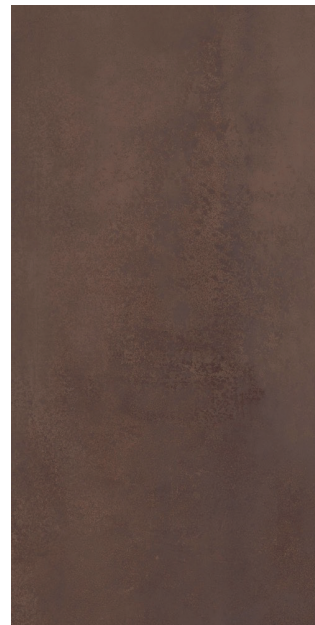

IRON RUGGINE

60X120 FO 117
60X60 FO 115
30X60 FO 115

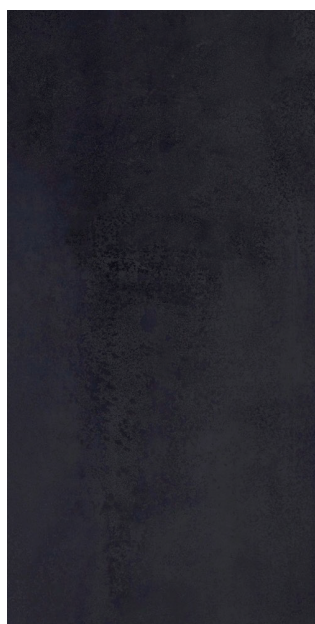

IRON ANTRACITE

60X120 FO 117
60X60 FO 115
30X60 FO 115



IRON DECORO FIORE

60X120 FO 118



IRON DECORO ESAGONE

60X120 FO 118

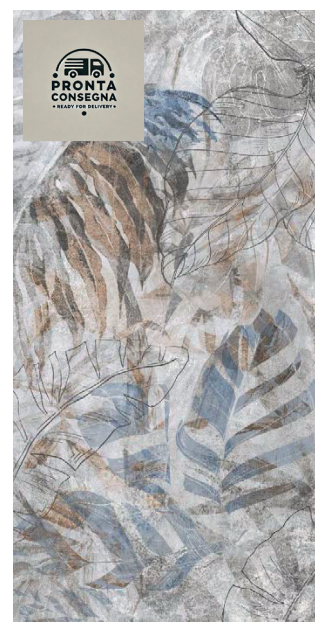

IRON DECORO TROPICO

60X120 FO 118

FORMATO	Spess. mm	Pz. x Scat.	M2 x scat. netto	Scat. x pall.	M2 x pall.	kg x scat.	kg x pall.
60x120	9,2	2	1,44	36	51,84	26,35	948,60
60x60	8,2	4	1,44	32	46,08	23,33	746
30x60	8,2	8	1,44	40	57,60	23,33	933

EVVIVA

MULTIFORMATO

60x60 / 30x60 / 60x120 / 80x80

COLORI



DECORI



EVVIVA

Multiformato + Grip 60x120 / 60x60 / 30x60

GP

Gres porcellanato smaltato

R

Rettificato

MC

Monocalibro

V3

Variazione Media



Resistenza al gelo



Opaco

DIGITAL TECHNOLOGY

Prodotti in Tecnologia Digitale



Per locali sottoposti a sollecitazioni medio/pesanti

Disponibile
Versione
R11



EVVIVA PERLA

60X120 FO 117
60X60 FO 115
30X60 FO 115

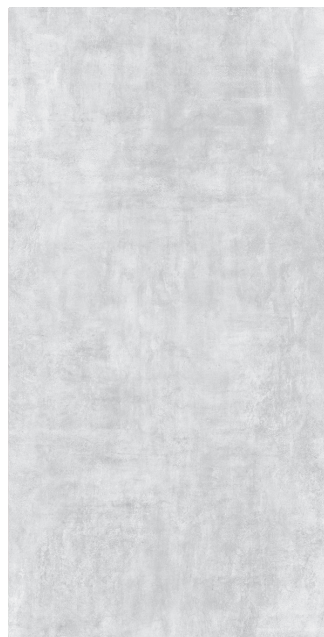

EVVIVA GRIGIO

60X120 FO 117
60X60 FO 115
30X60 FO 115

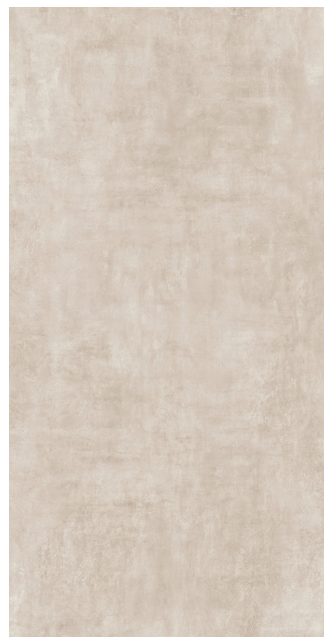

EVVIVA BEIGE

60X120 FO 117
60X60 FO 115
30X60 FO 115



EVVIVA TORTORA

60X120 FO 117
60X60 FO 115
30X60 FO 115



EVVIVA ANTRACITE

60X120 FO 117
60X60 FO 115
30X60 FO 115



EVVIVA DECORO
FOGLIE

60X120 FO 118



EVVIVA DECORO
GEOMETRICO

60X120 FO 118



EVVIVA DECORO
SELVA

60X120 FO 118

FORMATO	Spess. mm	Pz. x Scat.	M2 x scat. netto	Scat. x pall.	M2 x pall.	kg x scat.	kg x pall.
60x119,8	9,2	2	1,44	36	51,84	26,35	948,60
60x60	8,2	4	1,44	32	46,08	23,33	746
30x60	8,2	8	1,44	40	57,60	23,33	933

CALACATTA 60X120 / 60X60 GRMT



G.CL203 60119 LU BG RET
60x120 FO 118



G.CL003 60119 BEIGE RET
60x120 FO 117



G.CL003 600 BEIGE RET
60x60 FO 115



G.CL205 60119 LU GR RET
60x120 FO 118

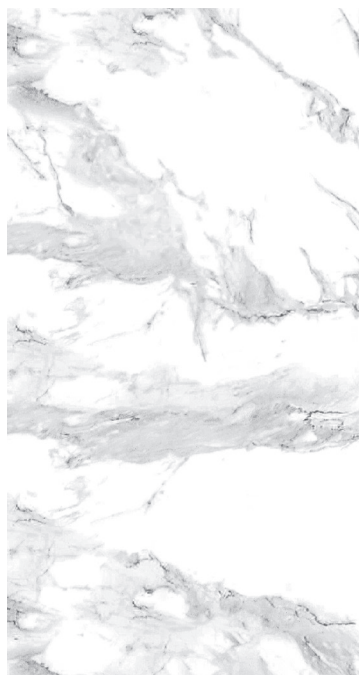

G.CL005 60119 GRIGIO RET
60x120 FO 117

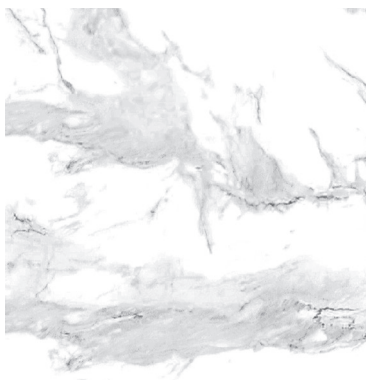

G.CL005 600 GRIGIO RET
60x60 FO 115

FORMATO	Spess. mm	Pz. x Scat.	M2 x scat. netto	Scat. x pall.	M2 x pall.	kg x scat.	kg x pall.
60x120	9.2	2	1,44	36	51,84	26,35	948,60
60x60	8.2	4	1,44	32	46,08	23,33	746

CL-CALACATTA 60x120 / 60x60



Calacatta Grey 60x120 - FO51



Calacatta Grey 60x60 - FO49



Calacatta Gold 60x60 - FO49



Calacatta Gold 60x120 - FO51

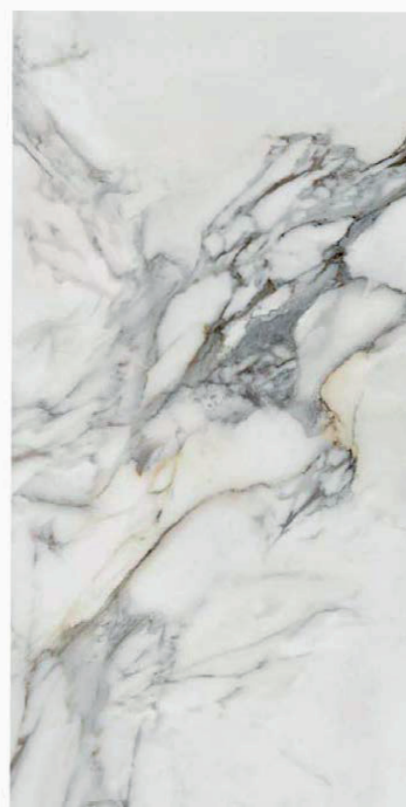

FORMATO	Spess. mm	Pz x Scat.	M2 x scat. netto	Scat. x pall.	M2 x pall.	kg x scat.	kg x pall.
60x120 rett	9,5	2	1,44	36	51,84	27,50	1010
60x60 rett.	9,5	4	1,44	30	43,20	28,15	864,50

SOSTANZA 30x60 Rettificato SPAZZOLATO

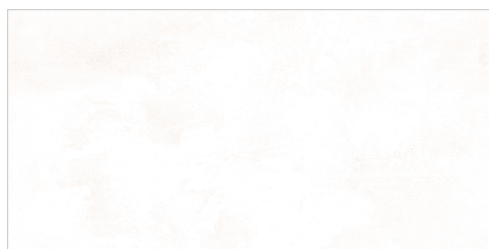

G.SO001 3060 NEUTRO RET SPZ
FO 62

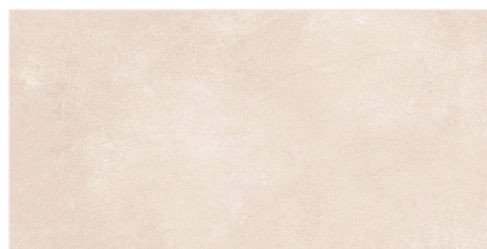

G.SO003 3060 BEIGE RET SPZ
FO 62



G.SO004 3060 TORTORA RET SPZ
FO 62



G.SO005 3060 GRIGIO RET SPZ
FO 62

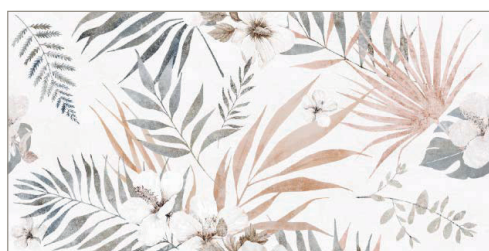

G.SO281 3060 IB RET SPZ
FO 63



G.SO261 3060 RO RET SPZ
FO 63



FORMATO	Spess. mm	Pz. x Scat.	M2 x scat. netto	Scat. x pall.	M2 x pall.	kg x scat.	kg x pall.
30x60	7,4	8	1,44	40	57,60	20,59	824

COLOR 25x60



Gres porcellanato smaltato



Rettificato



Monocalibro



Variazione Media



Resistenza al gelo



Opaco



Prodotti in Tecnologia Digitale



Plastrelle per pareti

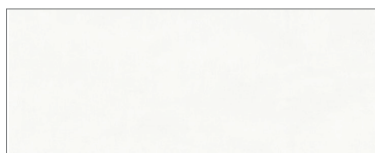

COLOR NEUTRO 25X60 FO 52

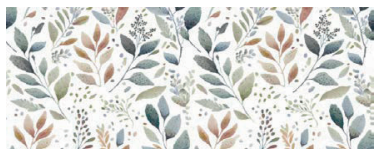

COLOR DECO MIX 25X60 FO 54

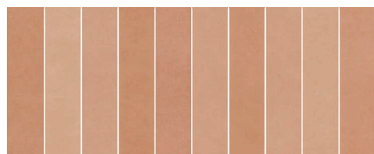

COLOR LIST. ORANGE FO 53

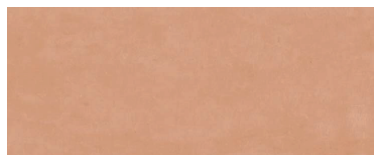

COLOR ORANGE 25X60 FO 52



COLOR NEUTRO 25X60 FO 52



COLOR DECO SPRING FO 54

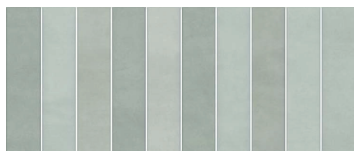

COLOR LIST. SALVIA FO 53

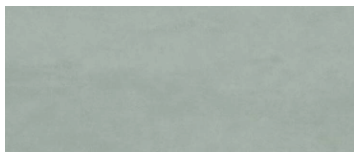

COLOR SALVIA 25X60 FO 52

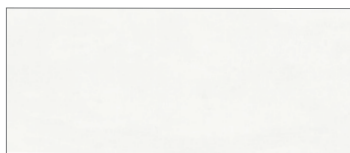

COLOR NEUTRO 25X60 FO 52

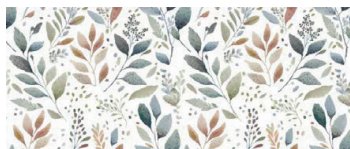

COLOR DECO MIX 25X60 FO 54



COLOR LIST. BEIGE FO 53

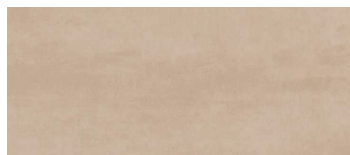

COLOR BEIGE 25X60 FO 52

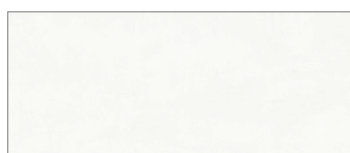

COLOR NEUTRO 25X60 FO 52

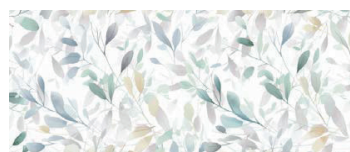

COLOR DECO SPRING FO 54

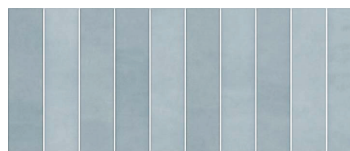

COLOR LIST. AZZURRO FO 53

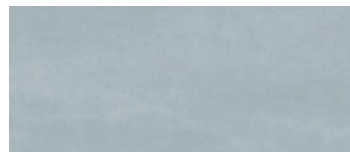

COLOR AZZURRO 25X60 FO 52

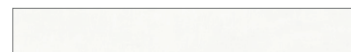

LISTELLO NEUTRO 8X60 LI 40



LISTELLO MIX 8X60 LI 40



LISTELLO NEUTRO 8X60 LI 40



LISTELLO SPRING 8X60 LI 40

FORMATO	Spess. mm	Pz. x Scat.	M2 x scat. netto	Scat. x pall.	M2 x pall.	kg x scat.	kg x pall.
25x60	8	10	1,50	48	72,00	19,20	921,60

RIVER 60x120 Rettificato - 30,5X61 / 15x30 Naturale



White 60x120 rett R11 - FO51



Gold 60x120 rett R11 - FO51



Silver 60x120 rett R11 - FO51



White 30,5x61 R11 - FO55

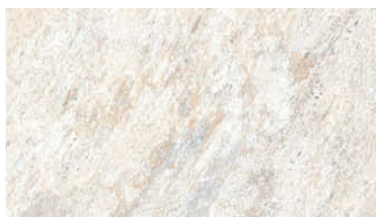

Gold 30,5x61 R11 - FO55

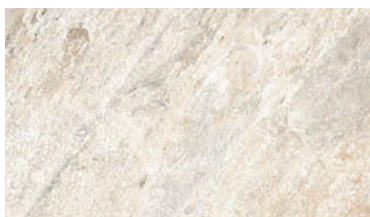

Silver 30,5x61 R11 - FO55



White 15x30 R11 - FO59

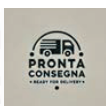

Gold 15x30 R11 - FO59



Silver 15x30 R11 - FO59

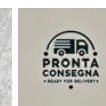

FORMATO	Spessore mm	Pz/Sc	Mq/Sc	Sc/PL	Mq/PL	Kg/Sc	Kg/PL
15x30	8,5 mm	22	0,99	84	83,16	17,9	1523
30,5x61	8,2 mm	8	1,49	60	89,40	23,50	1430,00
60x120 RT	9,5 mm	2	1,44	36	51,84	27,50	1010,00

ROCCIA 30,5x61 - RII



Gress porcellanato smaltato



Rettificato



Monocalibro



Variazione Media



Resistenza al gelo



Opaco



Prodotti in Tecnologia Digitale



Per locali sottoposti a sollecitazioni medio/pesanti



Roccia Bianco 30,5x61 - FO55



Roccia Sabbia 30,5x61 - FO55

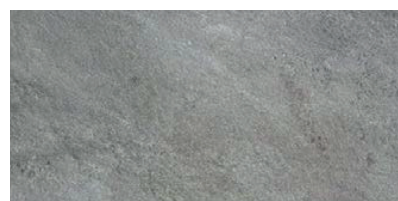

Roccia Grigio 30,5x61 - FO55

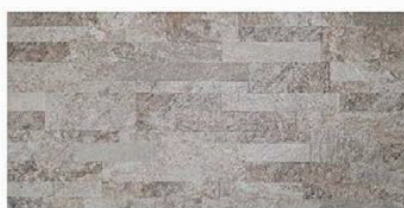

Muretto Roccia Sabbia 30,5x61 - FO55



Muretto Roccia grigio 30,5x61 - FO55

FORMATO	Spess. mm	Pz x Scat.	M2 x scat. netto	Scat. x pall.	M2 x pall.	kg x scat.	kg x pall.
30,5x61	8,2	8	1,49	60	89,4	23,50	1430

LE PIETRE 20X40 - R10



Gress porcellanato smaltato



Rettificato



Monocalibro



Variazione Media



Resistenza al gelo



Opaco



Prodotti in Tecnologia Digitale



Per locali sottoposti a sollecitazioni medio/pesanti



Le Pietre Beige 20x40,4 - FO 116



Le Pietre Greigio 20x40,4 - FO 116

Formato Nominale (cm)	Sp. mm	Pz/collo	m2/collo	Kg/collo	colli/plt	m2/plt	Kg/plt netto
20x40,4	8,2	18	1,46	23,64	48	70,08	1.135,00

CAMPIELLO 15x30 - R10

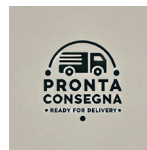

Campiello Bronzo - FO 59



Campiello Rame - FO 59



Campiello Oro - FO 59

RIVER 15x30 - R11



River White 15x30 - FO59



River Gold 15x30 - FO59

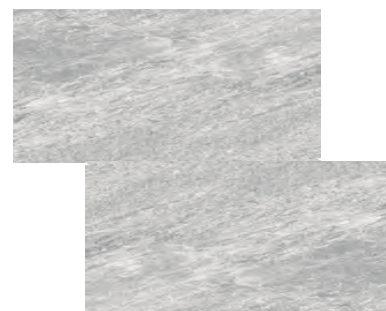

River Silver 15x30 - FO59

FORMATO	Spessore	Pz/Sc	Mq/Sc	Sc/PL	Mq/PL	Kg/Sc	Kg./PL
15x30	8,5 mm	22	0,99	84	83,16	17,9	1523

SALEPEPE 32,5X32,5 Gres porcellanato porfirizzato



SALEPEPE GREIGE 32,5X32,5 R10 mm12 spessorato - FO 60

SALEPEPE GREIGE 32,5X32,5 R10 mm 8,2 - FO 61

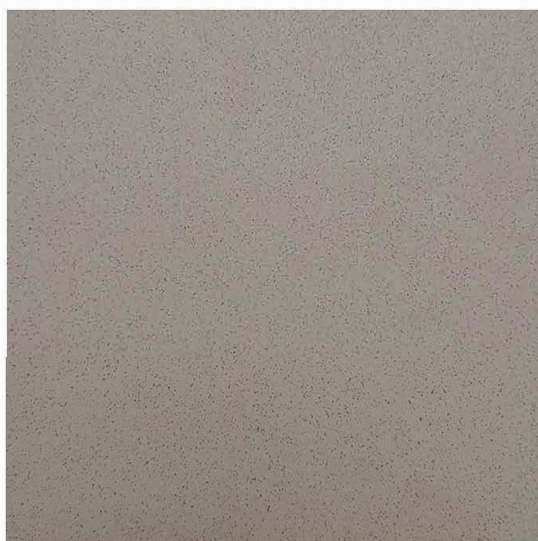

FORMATO	Spessore mm	Pz/Sc	Mq/Sc	Sc/PL	Mq/PL	Kg/Sc	Kg/PL
32,5x32,5	12 mm	9	0,95	69	65,55	20,15	1410,35
32,5x32,5	8,2 mm	14	1,48	69	102,12	22	1538



Sanitari

Sara

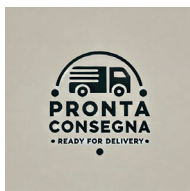

new



BIDET SARA FILO MURO 181-S300

MATERIALE Ceramica
FINITURE Bianco
SPECIFICHE Monoforo con troppopieno



181-S300-R Erogazione Rubinetto

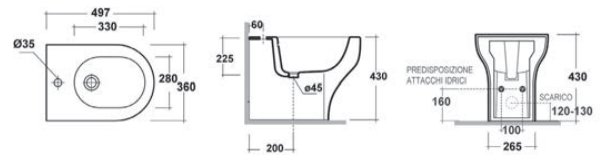

PREZZO DI LISTINO
€ 187,50 AL PZ SA220



BIDET SARA SOSPESO 181-S310

MATERIALE Ceramica
FINITURE Bianco
SPECIFICHE Monoforo con troppopieno, installazione sospesa



181-S310-R Erogazione Rubinetto

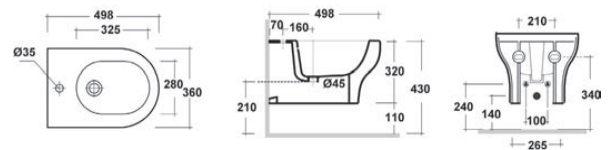

PREZZO DI LISTINO
€ 187,50 AL PZ SA221

VASO SARA FILO MURO RIMLESS 181-S400

MATERIALE Ceramica
FINITURE Bianco
SPECIFICHE Scarico universale pavimento/parete, installazione filomuro



181-S400 Scarico universale

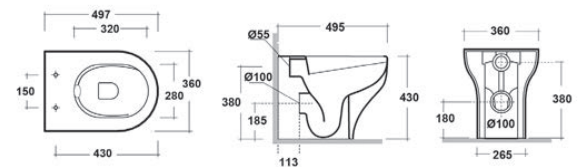

PREZZO DI LISTINO
€ 187,50 AL PZ SA 220



VASO SARA RIMLESS SOSPESO 181-S410

MATERIALE Ceramica
FINITURE Bianco
SPECIFICHE Scarico a parete, installazione sospesa



181-S410 -

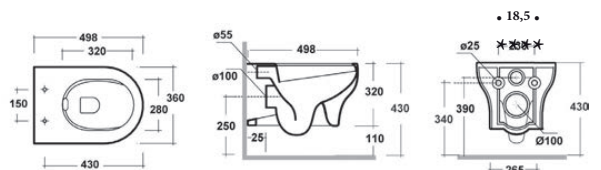

PREZZO DI LISTINO
€ 187,50 AL PZ SA221



SEDILE WC SARA CON SOFT CLOSING 181-S901

MATERIALE Termoplastico
FINITURE Bianco
SPECIFICHE Sottile. Con tecnologia softclose e sgancio rapido

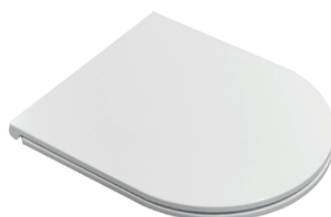

181-S901 Bianco soft closing

PREZZO DI LISTINO
€ 97,22 AL PZ SA222

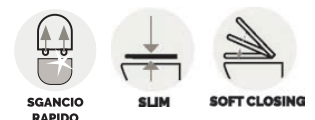

Sara

LAVABI, SIFONI + RUBINETTO CON FILTRO

Novità Pronta Consegna

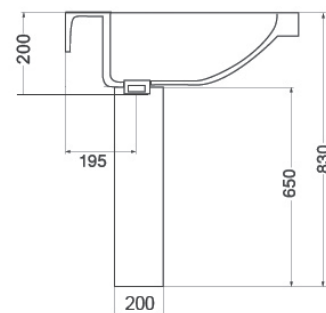
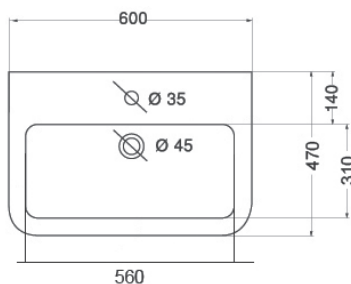

LAVABO JAS Monoforo L. 60 cm
LISTINO AL PEZZO € 86,03
SA223

COLONNA JAS 65 cm
LISTINO AL PEZZO € 76,70
SA224



S.002 SIFONE MINIMAL DESIGN QUADRO 1"1/4
LISTINO AL PEZZO: € 83,23 SA226



S.001 SIFONE MINIMAL DESIGN TONDO 1"1/4
LISTINO AL PEZZO: € 68,66 SA227



S.004 SIFONE MINIMAL TONDO RIBASSATO 1"1/4
LISTINO AL PEZZO: € 54,43 SA228



3020.1 Rubinetto sottolavabo con filtro, movimento a vitone, rosone inox scorrevole. Senza dado.
Cromato 1/2"X3/8"
LISTINO AL PZ: € 10,63
SA225



370-X01-07 SIFONE lavabo ad S a colonna senza piletta con canna da 25 cm modello LUX 1"1/4
LISTINO AL PZ: € 28,88
SA230



370-X00-07 SIFONE bidet ad S senza piletta con canna da 25 cm modello LUX 1"1/4
LISTINO AL PZ: € 27,35
SA229



Piletta 90 ribassata con coperchio
LISTINO AL PZ: € 20,00
SA 231

COLONNE ATTREZZATE ACCIAIO

Novità Pronta Consegna



Doccia attrezzata Evo struttura in Acciaio Inox,
Cromo Lucido, Spazzolato e Termostatico



***CROMO LUCIDA**
listino al pezzo:
€ 466,67
SA239



***CROMO SPAZZOLATA**
listino al pezzo:
€ 458,89
SA238



- [CARATTERISTICHE] Struttura colonna in acciaio inox con finitura cromo lucida o spazzolata - Rubinetto termostatico in ottone
- [ACCESSORI] Doccetta monogetto cromata con ugelli anticalcare - Flessibile doccia con attacchi conici FF½" ottone cromato da 150 cm
- [PERSONALIZZAZIONE] Getto effetto cascata e 1 Sistema idro lombare con ugelli anticalcare - Deviatore a 4 vie in ottone per soffione, cascata, doccetta e bocchette idro
- [DIMENSIONI] Le dimensioni sono L20 x 50 x 115 cm
- [PRODOTTO GARANTITO] La garanzia del prodotto da azienda Italiana è pari a 2 anni sempre attenti alla totale soddisfazione del cliente

Doccia Attrezzata Jungle Struttura in Acciaio Cromo, pazzolato, Gold e Nero



CROMO SPAZZOLATA
listino al pezzo:
€ 416,11 SA232
*** € 427,78 cascata**
SA234
CROMO LUCIDA
€ 423,89 SA233
*** € 435,56 cascata**
SA235



ORO LUCIDA
listino al pezzo:
€ 462,78
cascata SA 237



*** NERA OPACA**
listino al pezzo:
€ 443,33
cascata SA236

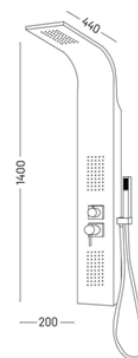

- [CARATTERISTICHE] Struttura colonna in acciaio con finitura nero opaca - Rubinetto a miscelatore in ottone
- [ACCESSORI] Doccetta monogetto nero opaco con ugelli anticalcare - Flessibile doccia con attacchi conici FF½" nero opaco da 150 cm
- [PERSONALIZZAZIONE] Getto effetto cascata e 2 Sistemi idro lombari con ugelli anticalcare - Deviatore a 4 vie in ottone per soffione, cascata, doccetta e bocchette idro
- [DIMENSIONI] Le dimensioni sono L20 x 44 x 140 cm
- [PRODOTTO GARANTITO] La garanzia del prodotto da azienda Italiana è pari a 2 anni sempre attenti alla totale soddisfazione del cliente

DOCCIA ATTREZZATA SMART

Struttura in Acciaio Inox, Cromo Lucido, Spazzolato, Black e Bianco



- [CARATTERISTICHE] Struttura colonna in acciaio inox con finitura cromo lucida o spazzolata - Rubinetto a miscelatore in ottone
- [ACCESSORI] Doccetta monogetto cromata con ugelli anticalcare - Flessibile doccia con attacchi conici FF½" ottone cromato da 150 cm
- [PERSONALIZZAZIONE] Getto effetto cascata e 2 Sistemi idro lombari con ugelli anticalcare - Deviatore a 4 vie in ottone per soffione, cascata, doccetta e bocchette idro
- [DIMENSIONI] Le dimensioni sono L23 x 50 x 150 cm
- [PRODOTTO GARANTITO] La garanzia del prodotto da azienda Italiana è pari a 2 anni sempre attenti alla totale soddisfazione del cliente

Pannello Doccia Attrezzata Steel Struttura in Acciaio Inox Cromo Lucido o Spazzolato



- [CARATTERISTICHE] Struttura colonna in acciaio inox con finitura cromo lucida o spazzolata - Soffione acciaio inox elettrosaldato spessore 4 mm. con ugelli anticalcare - Rubinetto a miscelatore in ottone
- [ACCESSORI] Doccetta monogetto cromata con ugelli anticalcare - Flessibile doccia con attacchi conici FF½" ottone cromato da 150 cm
- [PERSONALIZZAZIONE] Getto lombare e Presa acqua per attacco doccetta in ottone cromato - Deviatore a 3 vie in ottone per soffione, doccetta e getto lombare
- [DIMENSIONI] Le dimensioni sono L20 x 50 x 110 cm
- [PRODOTTO GARANTITO] La garanzia del prodotto da azienda Italiana è pari a 2 anni sempre attenti alla totale soddisfazione del cliente

LAVORAZIONI PEZZI SPECIALI

Un ulteriore servizio ALTAIR! Per la nostra Clientela realizziamo pezzi con lavorazioni speciali di elementi a "L", a "Becco di civetta", gradini "Costa retta", lavorazioni a Jolly e quant'altro su tutti i nostri prodotti. Per eventuali lavorazioni non raffigurate quali griglie, gradini antislip, etc. richiedi un preventivo ai nostri operatori.

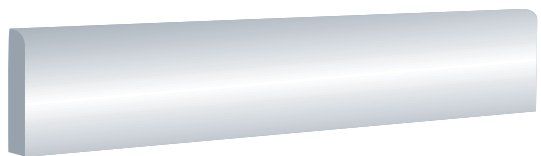

Lavorazione Becco di Civetta h. 7,5/8,5/9,5 cm
da 0 a 120 cm: €/ML LA 01

Lavorazione solo taglio netto h. 7,5/8,5/9,5 cm
da 0 a 120 cm: €/ML LA 02

Lavorazione a Jolly da 0 a 60 cm: €/ML LA 08
Lavorazione a Jolly da 61 a 120 cm: €/ML LA 13

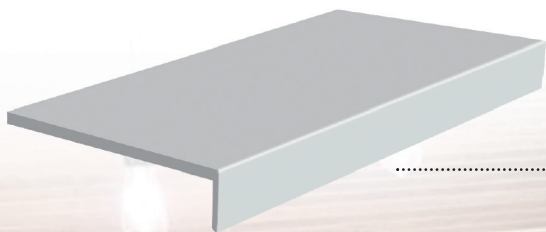

Elemento a "L" da taglio h. 4 cm
da 0 a 60 cm: €/ML LA 03

Elemento a "L" da taglio h. 4 cm
da 61 a 120 cm: €/ML LA 04

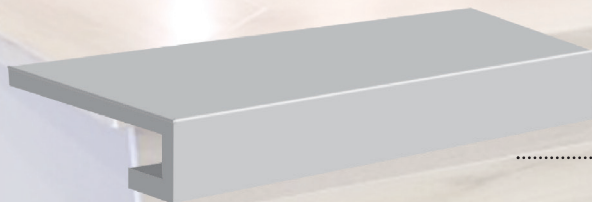

Gradino Costa Retta da taglio h. 4 cm
da 0 a 120 cm: €/ML LA 05









Angoli colonne h. da 0 a 10 cm, incollato
3 formati - €/PZ LA 06

Angoli colonne h. da 11 a 25 cm, incollato
3 formati - €/PZ LA 07

Importante: tutte le nostre lavorazioni sono effettuate sul tono che voi acquistate!

SIMBOLOGIA

Tipologia

	Gres porcellanato smaltato
	Gres porcellanato smaltato levigato
	Bicottura
	Rettificato
	Monocalibro
	Levigato
	Resina Minerale+Marmo + Geal Coat
	Aderenza media
	Aderenza elevata
	Disponibile palette intere Franco Sassuolo Disponibile su Roma solo su ordinazione

Nel catalogo troverai i riferimenti ai vari formati disponibili; le misure sono sempre indicate altezza (h) x base (b) e sono in centimetri. Per ogni serie di prodotto troverai anche una legenda con le simbologie che riassumono le caratteristiche principali dei nostri prodotti. In molte delle pagine potrai trovare anche il riferimento di pagina dei complementi consigliati in abbinamento al prodotto.





Rifinitura

	Opaco
	Semilucido
	Lucido
	Prodotto in Tecnologia Digitale



Tonalità miscelate

	Aspetto Uniforme
	Variazione Minima
	Variazione Media
	Variazione Sostanziale

Uso consigliato

	Piastrelle per pareti
	Materiali consigliati solo per bagni e camere da letto; ogni abrasione deve essere evitata
	Materiali consigliati per tutti i locali di un'abitazione, con esclusione dell'ingresso e della cucina; deboli sollecitazioni all'abrasione
	Materiali consigliati per qualsiasi locale di un'abitazione che non abbia collegamenti diretti con l'esterno o accessi non protetti da zerbini. Medie sollecitazioni all'abrasione
	Materiali consigliati per locali sottoposti a sollecitazioni medio pesanti come: case individuali, commerciale leggero, uffici, alberghi, ristoranti etc.

Caratteristiche tecniche

	Resistente al gelo
	Superfici con granelli abrasivi più resistenti allo scivolo

CONDIZIONI GENERALI DI VENDITA

- 1. OGGETTO DELLA FORNITURA** - La fornitura comprende esclusivamente quanto indicato nella conferma d'ordine. Eventuali caratteristiche e dati risultanti dai cataloghi o illustrazioni sono sempre approssimativi ed è quindi facoltà della Venditrice apportare quelle variazioni che si ritenessero opportune senza obbligo di preavviso.
- 2. ORDINI** - Sono sempre impegnativi per il Compratore: la Venditrice sarà vincolata solo dopo la conferma scritta. S'intende comunque che ogni ordine viene fatto con la completa accettazione da parte del Compratore di tutte le condizioni generali stabilite dalla Venditrice. Nell'ordinazione dovranno essere contemplati soltanto articoli di produzione corrente: non saranno comunque oggetto di conferma quei materiali per i quali la Venditrice indipendentemente da esigenze interne o di mercato, ha ritenuto opportuno sospendere la produzione. Ogni ordine deve essere inoltrato per iscritto, anche se, per ragioni di urgenza dovesse essere preceduto da comunicazione telefonica.
- 3. TRATTATIVE** - Quanto contemplato nella conferma della Venditrice annulla eventuali accordi o trattative che non siano riportati nella conferma stessa.
- 4. TERMINE DI CONSEGNA** - Decorre dalla data della conferma d'ordine e deve intendersi come approssimativo: esso non costituisce comunque condizione essenziale e può essere prorogato di diritto dalla Venditrice per cause indipendenti dalla propria volontà.
- 5. RECLAMI** - I reclami relativi ad eventuali ammanchi o rotture dovranno essere fatti esclusivamente al vettore: qualunque altro reclamo relativo alla natura e caratteristiche del materiale dovrà essere tempestivamente inoltrato alla Venditrice a mezzo lettera raccomandata, non oltre in ogni caso 10 gg. dal ricevimento della merce. TRASCORSO TALE TERMINE SI INTENDE CHE LA MERCE E' STATA VISTA ED ACCETTATA nello stato in cui si trova.
- 6. RESI** - Non si accettano resi di nessun genere salvo accordi concordati con la venditrice.
- 7. CARATTERISTICHE MATERIALI** - Le tonalità dei colori campionati hanno carattere puramente indicativo, così come la possibilità di ripetere tonalità precedentemente fornite, non rappresenta impegno per la fornitrice e motivo di reclamo per l'acquirente.
- 8. GARANZIA** - La Venditrice garantisce le qualità di quanto fornito conformemente alle scelte richieste dal Compratore: si impegna a sostituire in pari quantità quei materiali che, a suo insindacabile giudizio, dovessero presentare difetti tali da non essere considerati conformi all'ordine, senza peraltro essere tenuta a risarcimento di danni diretti o indiretti di qualsiasi ragione. La garanzia non è trasferibile ed è valida soltanto nei confronti dell'acquirente cui è intestata la fattura.
- 9. CONTESTAZIONI** - Nel modo più assoluto non saranno presi in esami i reclami riferentisi a materiali già in opera. In ogni caso, anche qualora il Compratore ritenesse di poter vantare reclami o diritti, non sono ammissibili ritardi o sospensioni di pagamento in corso.
- 10. INADEMPIENZE E INSOLVENZE** - In caso di mancato o ritardato pagamento totale o parziale, sarà facoltà della Venditrice risolvere in tutto o in parte qualsiasi contratto in atto, facendo valere ogni suo diritto.
- 11. PREZZI** - Si intendono sempre riferiti al listino in vigore al momento della conferma della Venditrice. Sono sempre relativi a merce franco stabilimento e non comprendono quindi altri oneri come IVA bolli o tasse di qualsiasi natura, che saranno sempre a carico del Compratore.
- 12. PAGAMENTI** - I pagamenti dovranno essere effettuati come indicato nella conferma d'ordine: a tutti gli effetti il luogo del pagamento resta fissato nella sede di Altair s.r.l. anche se effettuati a mezzo di personale autorizzato, rimessa diretta, tratte autorizzate o effetti. La Venditrice ha facoltà di porre in circolazione i titoli ricevuti in pagamento, i quali si intendono sempre accettati prosolvendo e salvo buon fine. L'inosservanza dei termini di pagamento dà diritto alla Venditrice:
 - di esigere gli interessi di mora al tasso commerciale corrente più le spese;
 - di emettere tratte ritenendole autorizzate in luogo dei pagamenti pattuiti per rimessa diretta;
 - di sospendere ogni evasione di ordini in corso;
 - in caso di protesti di esigere a vista l'importo totale dovutole.
- 13. SPESE TRATTE** - Gli oneri relativi al bollo delle tratte emesse dalla Venditrice sono a carico dell'acquirente e saranno conteggiate in fattura e comprese nella tratta stessa.
- 14. FORO** - Qualsiasi controversia dipendente o conseguente da contratti con Altair s.r.l., anche se riferibili ad affari trattati da proprio dipendenti o incaricati fuori dalla propria Sede, unico Foro competente è quello Velletri (Roma).



PAVIMENTI E RIVESTIMENTI PREZZO AL MQ.

Cod.	Palette	Mettrature	Cod.	Palette	Mettrature	Cod.	Palette	Mettrature	Cod.	Palette	Mettrature	Cod.	Palette	Mettrature
FO 24	33,61 €	37,50 €	FO 62	29,17 €	35,00 €	FO 107	26,39 €	32,78 €	FO 136	26,94 €	33,33 €	FO 160	36,11 €	39,44 €
FO 25	27,78 €	31,94 €	FO 63	30,33 €	37,50 €	FO 108	28,06 €	34,44 €	FO 140	34,17 €	38,89 €	FO 161	38,06 €	41,11 €
FO 26	32,47 €	33,61 €	FO 64	18,06 €	19,44 €	FO 109	27,75 €	35,07 €	FO 141	29,17 €	33,33 €	FO 162	38,89 €	42,22 €
FO 31	32,47 €	33,61 €	FO 72	37,50 €	40,28 €	FO 111	30,69 €	38,31 €	FO 142	34,24 €	39,58 €	FO 163	44,44 €	48,61 €
FO 35	26,94 €	33,33 €	FO 73	43,33 €	45,83 €	FO 112	30,21 €	37,78 €	FO 143	35,04 €	40,42 €	FO 164	29,72 €	31,94 €
FO 42	33,33 €	36,11 €	FO 74	41,67 €	44,44 €	FO 114	27,78 €	33,61 €	FO 144	34,24 €	39,58 €	FO 165	41,11 €	44,44 €
FO 44	40,28 €	43,06 €	FO 75	34,72 €	37,50 €	FO 115	29,58 €	36,11 €	FO 145	35,04 €	40,42 €	FO 166	35,28 €	38,33 €
FO 49	30,00 €	36,67 €	FO 76	36,11 €	38,89 €	FO 116	26,39 €	30,56 €	FO 147	27,22 €	33,61 €	FO 167	41,67 €	45,83 €
FO 50	36,11 €	40,28 €	FO 95	36,39 €	43,89 €	FO 117	36,11 €	43,61 €	FO 148	25,00 €	29,17 €	FO 168	33,33 €	36,11 €
FO 51	35,56 €	42,78 €	FO 96	36,39 €	44,44 €	FO 118	44,72 €	53,06 €	FO 149	30,56 €	38,89 €	FO 169	38,33 €	41,67 €
FO 52	25,83 €	31,94 €	FO 97	22,56 €	27,22 €	FO 119	31,58 €	37,50 €	FO 150	30,83 €	37,50 €	FO 170	34,72 €	37,50 €
FO 53	27,22 €	33,61 €	FO 98	23,06 €	28,89 €	FO 121	31,58 €	37,50 €	FO 151	30,83 €	37,50 €	FO 171	33,06 €	37,50 €
FO 54	28,33 €	34,72 €	FO 99	22,56 €	27,22 €	FO 124	33,06 €	40,00 €	FO 152	60,56 €	70,83 €	FO 172	25,83 €	31,94 €
FO 55	25,00 €	31,00 €	FO 100	38,89 €	45,00 €	FO 125	60,56 €	70,83 €	FO 153	25,28 €	30,56 €	FO 173	26,94 €	33,33 €
FO 56	30,00 €	36,67 €	FO 101	23,06 €	28,89 €	FO 127	18,61 €	20,83 €	FO 154	25,28 €	30,56 €	FO 174	27,22 €	33,61 €
FO 57	28,61 €	35,00 €	FO 102	21,94 €	27,78 €	FO 128	37,50 €	40,28 €	FO 155	30,00 €	36,39 €	FO 300	42,78 €	49,17 €
FO 58	38,89 €	48,61 €	FO 103	23,33 €	29,44 €	FO 129	35,56 €	37,50 €	FO 156	25,00 €	30,00 €	FO 400	60,00 €	67,78 €
FO 59	26,39 €	30,56 €	FO 104	23,33 €	29,44 €	FO 133	52,50 €	61,39 €	FO 157	25,00 €	29,17 €	FO 401	60,00 €	67,78 €
FO 60	36,11 €	41,67 €	FO 105	34,03 €	40,63 €	FO 134	30,00 €	36,67 €	FO 158	30,72 €	35,85 €	FO 501	57,78 €	65,28 €
FO 61	26,39 €	31,94 €	FO 106	26,39 €	32,78 €	FO 135	30,00 €	36,67 €	FO 159	30,72 €	35,85 €			

MOSAICI PREZZO AL PEZZO

Cod.	Quantità	Al pezzo	Cod.	Quantità	Al pezzo	Cod.	Quantità	Al pezzo	Cod.	Quantità	Al pezzo	Cod.	Quantità	Al pezzo
LI 19	27,78 €	37,50 €	LI 40	--	4,17 €	LI 54	--	8,33 €	LI 66	19,44 €	29,17 €	LI 76	19,44 €	29,17 €
LI 27	--	10,00 €	LI 43	--	6,94 €	LI 55	20,83 €	27,78 €	LI 67	--	4,17 €	LI 77	22,22 €	31,94 €
LI 34	--	5,00 €	LI 52	--	4,17 €	LI 56	16,11 €	23,61 €	LI 68	--	5,56 €			
LI 39	20,83 €	27,78 €	LI 53	--	5,56 €	LI 60	--	6,94 €	LI 69	--	8,33 €			

BATTISCOPA PREZZO AL METRO LINEARE

Cod.	Palette	Scatola	Cod.	Palette	Scatola	Cod.	Palette	Scatola
L 33	3,33 €	4,86 €	L 45	4,17 €	5,83 €	L 60	5,56 €	7,22 €

LAVORAZIONI BATTISCOPA GRADINI E PEZZI SPECIALI PREZZO AL PEZZO / METRO LINEARE

Cod.	Quantità	Al pezzo	Cod.	Quantità	Al pezzo	Cod.	Quantità	Al pezzo	Cod.	Quantità	Al pezzo	Cod.	Quantità	Al pezzo
LA 01	--	6,25 €	LA 04	--	69,44 €	LA 07	--	8,33 €	LA 10	--	12,50 €	LA 13	--	16,67 €
LA 02	--	4,17 €	LA 05	--	102,78 €	LA 08	--	8,33 €	LA 11	--	102,78 €			
LA 03	--	50,00 €	LA 06	--	5,56 €	LA 09	--	12,50 €	LA 12	--	11,11 €			

BOX DOCCIA PREZZO AL PEZZO

Cod.	Quantità	Al pezzo	Cod.	Quantità	Al pezzo	Cod.	Quantità	Al pezzo	Cod.	Quantità	Al pezzo	Cod.	Quantità	Al pezzo
BX 01	489,91 €	519,91 €	BX 12	491,87 €	522,98 €	BX 23	635,31 €	663,31 €	BX 35	321,30 €	351,30 €	BX 46	355,21 €	385,21 €
BX 02	516,86 €	546,86 €	BX 13	502,75 €	532,75 €	BX 24	658,18 €	688,18 €	BX 36	321,30 €	351,30 €	BX 47	579,67 €	609,67 €
BX 03	544,04 €	574,04 €	BX 14	541,51 €	571,51 €	BX 25	245,74 €	275,74 €	BX 37	524,03 €	554,03 €	BX 48	340,43 €	370,43 €
BX 04	260,13 €	290,13 €	BX 15	567,19 €	597,19 €	BX 26	257,91 €	287,91 €	BX 38	546,98 €	576,98 €	BX 49	371,03 €	401,73 €
BX 05	285,34 €	315,34 €	BX 16	253,71 €	283,71 €	BX 28	267,75 €	297,75 €	BX 39	566,10 €	596,10 €	BX 50	390,15 €	420,15 €
BX 06	530,49 €	560,49 €	BX 17	277,89 €	307,89 €	BX 29	279,23 €	309,23 €	BX 40	248,63 €	278,63 €	BX 51	447,53 €	477,53 €
BX 07	553,79 €	583,79 €	BX 18	605,74 €	635,74 €	BX 30	279,23 €	309,23 €	BX 41	260,10 €	290,10 €	BX 52	470,48 €	500,48 €
BX 08	584,78 €	614,78 €	BX 19	633,31 €	663,31 €	BX 31	286,88 €	316,88 €	BX 42	485,78 €	515,78 €	BX 53	504,90 €	534,90 €
BX 09	334,68 €	364,68 €	BX 20	605,74 €	635,74 €	BX 32	286,88 €	316,88 €	BX 43	754,87 €	784,87 €			
BX 10	357,98 €	387,98 €	BX 21	620,02 €	650,02 €	BX 33	298,35 €	328,35 €	BX 44	723,81 €	753,81 €			
BX 11	476,00 €	507,11 €	BX 22	647,51 €	677,51 €	BX 34	298,35 €	328,35 €	BX 45	335,99 €	365,99 €			

ORDINI

Fax: 069344793 ✉ ordini@ceramichealtair.com

LEGENDA

- = COLONNA PALETTE/QUANTITÀ VALIDA "FRANCO FABBRICA"
- = COLONNA METRATURE/AL PEZZO VALIDA "FRANCO DEPOSITO ROMA"



SANITARI E PIATTI DOCCIA PREZZO AL PEZZO

Cod.	Palette	Al pezzo	Cod.	Palette	Al pezzo	Cod.	Palette	Al pezzo	Cod.	Palette	Al pezzo	Cod.	Palette	Al pezzo
SA 01	366,66 €	392,85 €	SA 35	225,00 €	232,50 €	SA 123	37,95 €	37,95 €	SA 170	108,68 €	108,68 €	SA 211	150,00 €	157,50 €
SA 02	433,44 €	464,40 €	SA 36	236,25 €	243,75 €	SA 124	23,48 €	23,48 €	SA 171	163,99 €	163,99 €	SA 212	51,39 €	51,39 €
SA 03	364,14 €	390,15 €	SA 65	226,80 €	234,30 €	SA 125	38,25 €	38,25 €	SA 172	239,51 €	239,51 €	SA 213	60,00 €	63,75 €
SA 04	384,30 €	411,75 €	SA 66	239,21 €	246,71 €	SA 126	331,88 €	331,88 €	SA 173	101,10 €	101,10 €	SA 214	131,10 €	138,75 €
SA 05	443,52 €	475,20 €	SA 67	247,50 €	255,00 €	SA 127	183,75 €	187,50 €	SA 175	15,28 €	15,28 €	SA 215	99,90 €	107,40 €
SA 06	485,10 €	519,75 €	SA 80	225,00 €	232,50 €	SA 141	294,00 €	303,38 €	SA 176	6,94 €	6,94 €	SA 225	10,63 €	10,63 €
SA 07	413,28 €	442,80 €	SA 81	97,50 €	97,50 €	SA 142	71,82 €	81,20 €	SA 177	30,56 €	30,56 €	SA 226	83,23 €	83,23 €
SA 08	476,28 €	510,30 €	SA 82	142,50 €	142,50 €	SA 143	116,67 €	125,00 €	SA 188	11,11 €	11,11 €	SA 227	68,66 €	68,66 €
SA 09	520,38 €	557,55 €	SA 90	262,50 €	270,00 €	SA 144	378,34 €	387,71 €	SA 189	124,95 €	124,95 €	SA 228	54,43 €	54,43 €
SA 10	572,04 €	612,90 €	SA 99	183,75 €	187,50 €	SA 145	436,05 €	445,43 €	SA 190	75,68 €	75,68 €	SA 229	27,35 €	27,35 €
SA 11	529,20 €	567,00 €	SA 100	97,22 €	97,22 €	SA 146	461,70 €	471,08 €	SA 191	16,11 €	19,44 €	SA 230	28,88 €	28,88 €
SA 12	578,34 €	619,65 €	SA 101	81,94 €	86,03 €	SA 147	269,33 €	278,70 €	SA 192	44,44 €	47,22 €	SA 231	20,00 €	20,00 €
SA 13	636,30 €	681,75 €	SA 102	73,05 €	76,70 €	SA 148	277,02 €	286,40 €	SA 193	139,88 €	158,63 €	SA 232	382,50 €	416,11 €
SA 14	292,60 €	300,38 €	SA 104	189,00 €	196,50 €	SA 149	577,13 €	586,50 €	SA 194	255,56 €	274,31 €	SA 233	390,00 €	423,89 €
SA 15	277,78 €	320,33 €	SA 105	91,80 €	102,78 €	SA 150	307,80 €	315,30 €	SA 195	165,56 €	184,31 €	SA 234	393,75 €	427,78 €
SA 16	354,17 €	406,78 €	SA 107	450,00 €	513,18 €	SA 151	800,28 €	809,66 €	SA 196	289,58 €	308,33 €	SA 235	401,25 €	435,56 €
SA 17	450,00 €	513,18 €	SA 108	544,44 €	619,58 €	SA 152	5,56 €	6,94 €	SA 197	124,61 €	143,36 €	SA 236	408,75 €	443,33 €
SA 18	266,67 €	307,03 €	SA 109	638,89 €	725,98 €	SA 153	27,78 €	30,56 €	SA 198	273,30 €	292,05 €	SA 237	427,50 €	462,78 €
SA 19	295,83 €	340,28 €	SA 110	250,09 €	259,46 €	SA 155	77,78 €	77,78 €	SA 199	121,54 €	140,29 €	SA 238	423,75 €	458,89 €
SA 20	402,78 €	459,98 €	SA 111	250,09 €	259,46 €	SA 156	86,11 €	86,11 €	SA 200	217,39 €	236,14 €	SA 239	431,25 €	466,67 €
SA 21	497,22 €	566,38 €	SA 112	100,00 €	105,56 €	SA 157	41,67 €	41,67 €	SA 201	304,69 €	323,44 €	SA 240	431,25 €	466,67 €
SA 22	210,00 €	217,50 €	SA 113	257,78 €	267,16 €	SA 160	59,72 €	58,33 €	SA 202	154,99 €	173,74 €	SA 241	446,25 €	482,22 €
SA 23	240,00 €	247,50 €	SA 114	257,78 €	267,16 €	SA 161	67,50 €	78,75 €	SA 203	304,69 €	323,44 €	SA 242	442,50 €	478,33 €
SA 24	206,25 €	213,75 €	SA 115	187,88 €	187,88 €	SA 162	225,00 €	234,38 €	SA 204	114,79 €	133,54 €	SA 243	431,25 €	466,67 €
SA 25	255,00 €	262,50 €	SA 116	54,15 €	54,15 €	SA 163	225,00 €	234,38 €	SA 205	228,83 €	247,58 €	SA 244	520,24 €	558,95 €
SA 26	363,75 €	371,25 €	SA 117	89,78 €	89,78 €	SA 164	225,00 €	234,38 €	SA 206	651,42 €	697,95 €	SA 245	532,65 €	571,82 €
SA 27	637,50 €	645,00 €	SA 118	175,46 €	175,46 €	SA 165	172,50 €	172,50 €	SA 207	709,38 €	760,05 €			
SA 32	292,50 €	300,00 €	SA 119	86,51 €	86,51 €	SA 166	77,74 €	77,74 €	SA 208	65,25 €	72,75 €			
SA 33	405,00 €	412,50 €	SA 120	58,33 €	58,33 €	SA 167	104,51 €	104,51 €	SA 209	74,70 €	82,20 €			
SA 34	678,75 €	686,25 €	SA 121	30,38 €	30,38 €	SA 169	207,15 €	207,15 €	SA 210	85,65 €	93,15 €			

RUBINETTERIE E COLONNE DOCCIA PREZZO AL PEZZO

Cod.	Palette	Al pezzo	Cod.	Palette	Al pezzo	Cod.	Palette	Al pezzo	Cod.	Palette	Al pezzo
RB 27	121,62 €	134,55 €	RB 40	123,32 €	127,02 €	RB 54	450,77 €	464,29 €	RB 67	114,82 €	118,26 €
RB 28	82,07 €	84,54 €	RB 41	216,88 €	223,38 €	RB 55	578,34 €	595,69 €	RB 68	76,55 €	78,84 €
RB 29	59,54 €	61,32 €	RB 43	531,56 €	547,51 €	RB 56	136,08 €	140,16 €	RB 69	140,33 €	144,54 €
RB 30	145,44 €	149,80 €	RB 44	229,64 €	236,52 €	RB 57	378,47 €	389,83 €	RB 109	263,66 €	271,56 €
RB 32	195,19 €	201,05 €	RB 45	178,61 €	183,96 €	RB 58	75,69 €	77,97 €	RB 112	97,81 €	100,74 €
RB 33	144,59 €	148,92 €	RB 46	144,59 €	148,92 €	RB 59	327,44 €	337,27 €	RB 113	276,41 €	284,70 €
RB 34	136,08 €	140,16 €	RB 47	221,13 €	227,76 €	RB 60	378,47 €	389,83 €	RB 115	280,67 €	289,08 €
RB 35	89,30 €	91,98 €	RB 49	127,15 €	130,96 €	RB 62	191,36 €	197,10 €	RB 116	225,00 €	232,50 €
RB 36	170,10 €	175,20 €	RB 50	74,42 €	76,65 €	RB 63	204,12 €	210,24 €			
RB 38	242,39 €	249,66 €	RB 51	63,36 €	65,26 €	RB 64	229,64 €	236,52 €			
RB 39	167,97 €	173,01 €	RB 52	144,59 €	148,92 €	RB 65	127,58 €	131,40 €			

MOBILI DA BAGNO PREZZO AL PEZZO

Cod.	Quantità	Al pezzo	Cod.	Quantità	Al pezzo	Cod.	Quantità	Al pezzo	Cod.	Quantità	Al pezzo
MB 01	280,31 €	314,81 €	MB 10	357,78 €	407,61 €	MB 16	388,13 €	422,63 €	MB 22	1121,25 €	1259,25 €
MB 02	150,94 €	185,44 €	MB 11	268,33 €	314,97 €	MB 17	409,69 €	444,19 €	MB 23	927,19 €	1065,19 €
MB 03	64,69 €	99,19 €	MB 12	409,69 €	444,19 €	MB 18	431,25 €	465,75 €	MB 31	581,39 €	639,21 €
MB 04	409,69 €	444,19 €	MB 13	301,88 €	336,38 €	MB 19	51,75 €	56,06 €			
MB 07	491,94 €	546,57 €	MB 14	323,44 €	357,94 €	MB 20	602,15 €	639,21 €			
MB 08	129,38 €	163,88 €	MB 15	345,00 €	379,50 €	MB 21	215,63 €	250,13 €			

LEGENDA = COLONNA PALETTE/QUANTITÀ VALIDA "FRANCO FABBRICA"
 = COLONNA METRATURE/AL PEZZO VALIDA "FRANCO DEPOSITO ROMA"



Altair Ceramiche

Viale Virgilio, 58/C

41123 Modena (MO)

Tel. 06 93476822 - 06 93896926

Fax 06 9344793

info@ceramichealtair.com

www.ceramichealtair.com